

SUMINISTROS MALPICA, S.L.

TARIFA 2024

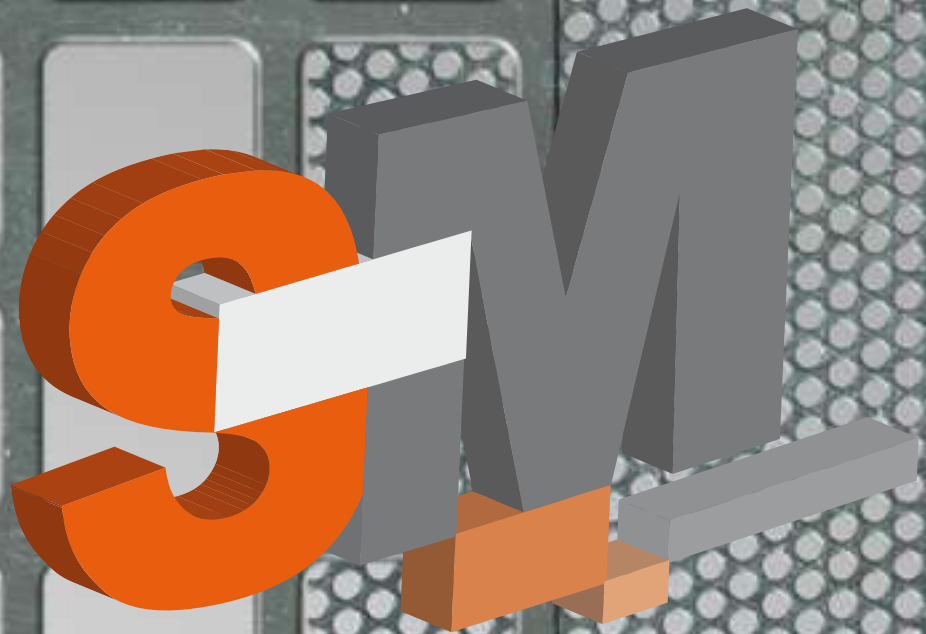

Siempre a tu Servicio

índice tarifa 2024

- _04 chapas perforadas hierro
- _05 chapas perforadas galvanizadas
- _05 chapas molinería
- _06 chapas decorativas
- _07 chapas repujadas
- _07 stepbloc
- _08 malla deployé
- _09 deployé arquitectura
- _10 entramado metálico (tramex)
- _12 aluacero
- _13 peldaños
- _14 escalera caracol



SM

Chapa perforada
Chapa repujada y stepbloc
Deployé
Entramado Tramex
Aluacero
Peldaños
Escalera caracol

chapas perforadas hierro

PERFORACIONES REDONDAS - 2.000x1.000								
PERF. RED.	1 mm	1,5 mm	2 mm	3 mm	4 mm	5 mm	6 mm	8 mm
1 mm	107,10 €							
1,2 mm	107,10 €							
1,5 mm	107,10 €	129,58 €						
2 mm	70,29 €	118,04 €	136,50 €					
2,5mm	70,29 €	118,04 €	136,50 €					
3 mm	63,84 €	82,39 €	117,00 €	256,75 €				
3,5 mm	63,84 €	118,75 €	117,00 €	245,35 €				
4 mm	63,84 €	75,46 €	87,75 €	230,76 €	267,60 €			
5 mm	63,84 €	72,23 €	83,85 €	198,72 €	235,20 €	372,00 €		
6 mm	57,12 €	72,23 €	81,90 €	190,08 €	232,80 €	357,84 €	372,00 €	
7 mm	57,12 €	86,24 €	99,65 €	203,04 €	232,80 €	348,36 €	372,00 €	
8 mm	54,60 €	67,91 €	81,90 €	177,12 €	227,76 €	331,20 €	369,60 €	624,44 €
9 mm	60,48 €	86,24 €	94,38 €	201,00 €	227,76 €	331,20 €	369,60 €	624,44 €
10 mm	49,56 €	67,91 €	79,95 €	170,64 €	216,60 €	331,20 €	357,60 €	551,45 €
12 mm	49,56 €	83,01 €	94,38 €	192,96 €	216,60 €	331,20 €	357,60 €	551,45 €
14 mm	49,56 €	83,01 €	94,38 €	192,96 €	216,60 €	331,20 €	357,60 €	551,45 €
15 mm	46,03 €	83,01 €	88,92 €	190,08 €	214,20 €	330,00 €	355,20 €	551,45 €
16 mm	47,88 €	83,01 €	88,92 €	190,08 €	214,20 €	330,00 €	355,20 €	544,44 €
18 mm	47,88 €	83,01 €	88,92 €	190,08 €	214,20 €	330,00 €	355,20 €	544,44 €
20,22 mm	45,21 €	79,77 €	85,02 €	184,32 €	214,20 €	316,80 €	352,80 €	544,44 €
25,28 mm	43,85 €	74,38 €	83,46 €	177,84 €	212,64 €	312,00 €	348,00 €	510,50 €
30,35 mm	43,85 €	73,30 €	83,46 €	177,12 €	212,40 €	310,80 €	345,60 €	510,50 €
40,45 mm	43,85 €	73,30 €	83,46 €	177,12 €	212,40 €	310,80 €	345,60 €	510,50 €
50,60 mm	43,85 €	73,30 €	83,46 €	177,12 €	212,40 €	310,80 €	345,60 €	510,50 €

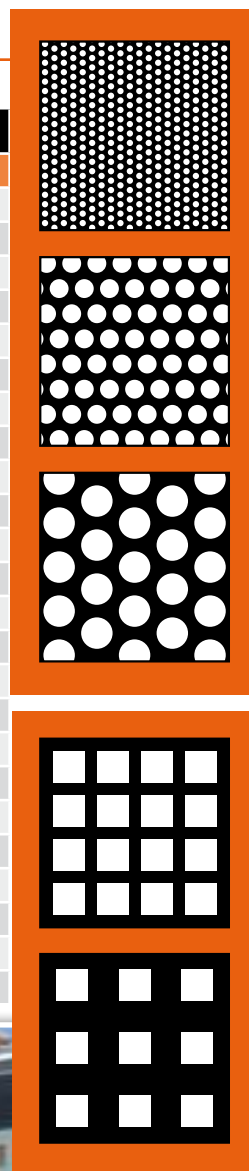

PERFORACIONES CUADRADAS - 2.000x1.000					
PERF. RED.	NERVIO	1 mm	1,5 mm	2 mm	3 mm
C5 mm	3 mm	99,60 €	84,08 €	117,81 €	
C8 mm	3 mm	99,60 €	84,08 €	101,97 €	
C10 mm	3 mm	99,60 €	84,08 €	99,00 €	
C10 mm	5 mm	99,60 €	84,08 €	99,00 €	223,08 €
C10 mm	10 mm	99,60 €	84,08 €	99,00 €	215,28 €
C15 mm	5 mm	99,60 €	77,00 €	99,00 €	221,52 €
C15 mm	15 mm	93,60 €	77,00 €	99,00 €	213,72 €
C20 mm	5 mm	93,60 €	77,00 €	96,03 €	213,72 €
C20 mm	20 mm	72,00 €	67,91 €	91,08 €	195,00 €
C30 mm	30 mm	72,00 €	67,91 €	86,13 €	195,00 €
C40 mm	40 mm	72,00 €	67,91 €	86,13 €	185,64 €
C50 mm	50 mm	72,00 €	74,38 €	86,13 €	185,64 €



También se fabrican chapas a medida. Consultar.

CHAPAS PERFORADAS - 3.000x1.500			
PERF. RED.	NERVIO	1,5 mm	2 mm
R2 mm		204,96 €	
R3 mm		168,00 €	213,36 €
R4 mm		168,00 €	213,36 €
R5 mm		157,92 €	207,48 €
R6 mm		155,40 €	183,12 €
R8 mm		155,40 €	180,60 €
R10 mm		155,40 €	180,60 €
CU 8 mm	3 mm	168,00 €	193,20 €
CU 10 mm	5 mm	166,32 €	186,48 €
CU 10 mm	10 mm	166,32 €	186,48 €
CU 15 mm	15 mm	155,40 €	181,44 €
CU 20 mm	20 mm	147,00 €	172,20 €
CU 30 mm	30 mm	147,00 €	172,20 €
CU 40 mm	40 mm	147,00 €	172,20 €

chapas perforadas galvanizadas

PERFORACIONES REDONDAS GALVANIZADAS - 2.000x1.000

PERF. RED.	0,5 mm	0,8 mm	1 mm	1,5 mm	2 mm	3 mm
R2 mm	85,41 €	75,47 €	78,98 €	87,02 €		
R3 mm	74,88 €	70,20 €	74,59 €	80,44 €	96,72 €	252,72 €
R4 mm	74,88 €	70,20 €	74,59 €	78,98 €	96,72 €	248,51 €
R5 mm	60,84 €	64,94 €	70,20 €	78,98 €	93,60 €	240,08 €
R6 mm	59,67 €	64,06 €	70,20 €	77,51 €	91,26 €	231,66 €
R8 mm	58,50 €	63,18 €	70,20 €	76,79 €	91,26 €	231,66 €
R10 mm	58,50 €	63,18 €	69,33 €	76,79 €	89,70 €	228,85 €
R12 mm	58,50 €	63,18 €	69,33 €	76,79 €	89,70 €	227,45 €
R15 mm	58,50 €	61,43 €	68,45 €	76,05 €	88,14 €	227,45 €
R20 mm	58,50 €	61,43 €	68,45 €	76,05 €	88,14 €	227,45 €

PERFORACIONES CUADRADAS GALVA. - 2.000x1.000

PERF. RED.	NERVIO	1,0 mm	1,5 mm	2,0 mm	3,0 mm
C5 mm	3 mm	106,47 €	90,09 €	113,20 €	
C8 mm	3 mm	102,96 €	84,36 €	107,06 €	
C10 mm	3 mm	102,96 €	84,36 €	107,06 €	
C10 mm	5 mm	101,79 €	84,36 €	106,18 €	234,23 €
C10 mm	10 mm	99,45 €	82,72 €	105,30 €	231,19 €
C15 mm	5 mm	81,90 €	73,71 €	94,77 €	234,23 €
C15 mm	15 mm	81,90 €	73,71 €	94,77 €	234,23 €
C20 mm	5 mm	74,88 €	72,07 €	92,14 €	229,67 €
C20 mm	20 mm	74,88 €	72,07 €	92,14 €	220,55 €
C30 mm	30 mm	74,88 €	72,07 €	92,14 €	220,55 €
C40 mm	40 mm	74,88 €	72,07 €	92,14 €	220,55 €
C50 mm	50 mm	74,88 €	72,07 €	92,14 €	220,55 €



También se fabrican chapas a medida. Consultar.

CHAPAS PERFORADAS GALVANIZADAS 3.000x1.500

PERF. RED.	NERVIO	1,5 mm	2,0 mm
R2 mm		220,92 €	
R3 mm		184,80 €	231,00 €
R4 mm		178,92 €	230,16 €
R5 mm		168,00 €	213,36 €
R6 mm		162,12 €	201,60 €
R8 mm		158,76 €	199,92 €
R10 mm		158,76 €	184,80 €
CU 10 mm	NV 5 mm	180,60 €	204,12 €
CU 10 mm	NV 10 mm	174,72 €	200,76 €
CU 15 mm	NV 15 mm	173,04 €	198,24 €
CU 20 mm	NV 20 mm	152,88 €	196,56 €
CU 30 mm	NV 30 mm	152,88 €	196,56 €
CU 40 mm	NV 40 mm	152,88 €	196,56 €

chapas molinería

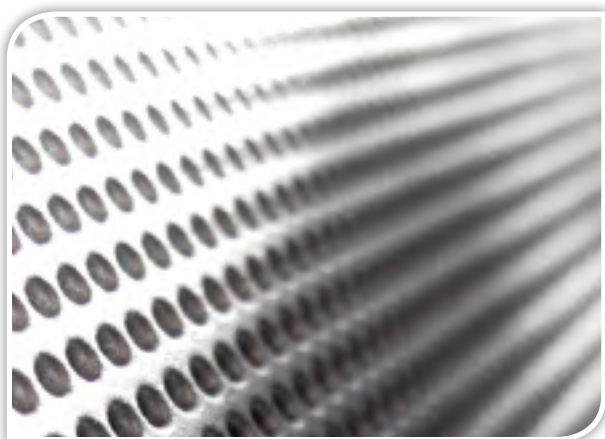

CHAPAS HIERRO MOLINERÍA - 2.000x1.000

PERF. RED.	DIS. CENT.	CO. PERF.	2 mm	2,5 mm	3 mm
2 mm	3 mm	40%	165,76 €		
2,5 mm	3,5 mm	46%	137,98 €	181,89 €	
3 mm	4 mm	50%	137,09 €	175,62 €	201,60 €
3,5 mm	4,5 mm	55%	136,19 €	171,14 €	193,54 €
4 mm	5,5 mm	48%	132,61 €	143,36 €	175,62 €
4,5 mm	6 mm	51%	132,61 €	140,67 €	172,03 €
5 mm	6,5 mm	53%	130,82 €	138,88 €	169,34 €
6 mm	7,5 mm	57%	129,92 €	137,98 €	167,55 €
7 mm	10 mm	54%	139,78 €	153,10 €	173,20 €
8 mm	11 mm	48%	107,52 €	137,09 €	164,86 €
9 mm	11 mm	58%	107,52 €	137,09 €	164,86 €
10 mm	12,5 mm	58%	107,52 €	137,09 €	164,86 €

chapas decorativas

PERFORACIONES DECORATIVAS HIERRO 2.000x1.000

MODELO	1,0 mm	1,5 mm
REF. 500	86,87 €	110,08 €
REF. 501	86,87 €	110,08 €
REF. 504	86,87 €	110,08 €
REF. 505	86,87 €	110,08 €
REF. 508	86,87 €	110,08 €
REF. 509	86,87 €	110,08 €
REF. 513	86,87 €	110,08 €
REF. 561	86,87 €	110,08 €

PERFORACIONES ABOCARDADAS - 2.000x1.000

	1,5 FE	2,0 FE	1,5 GALV.	2,0 GALV.
ABOC 7x20 ALT.	135,66 €	142,80 €	173,74 €	177,31 €
ABOC. 8 RECANORM.	116,62 €	121,38 €	124,95 €	130,90 €
ABOC. 15 mm T-24	127,33 €	133,28 €	152,32 €	159,46 €

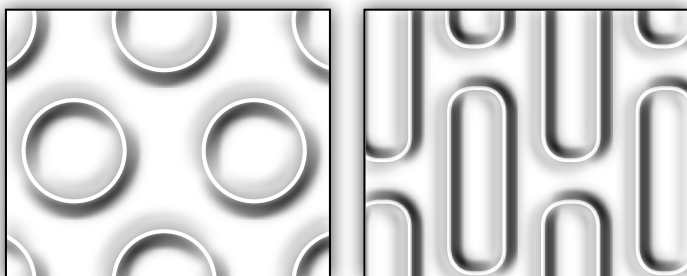

PERFORACIONES TRENZADAS - 2.000x1.000 DIAGONAL

	1,5 FE
TRENZADA CUAD 20	80,02 €
TRENZADA CUAD 30	76,05 €

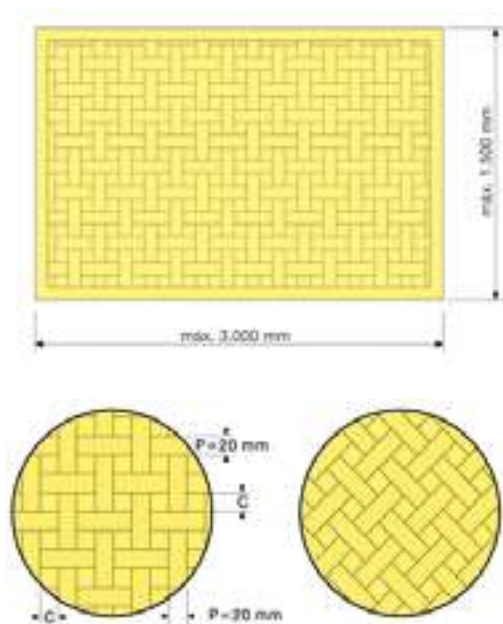

C = Lado del cuadrado, variable (20-30-40-50 mm)
P = Ancho del nervio, 20-30 mm

REF. 512

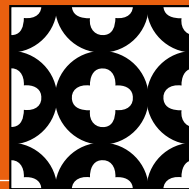

REF. 500

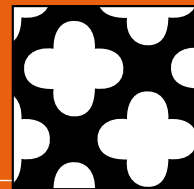

REF. 513

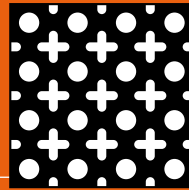

REF. 501

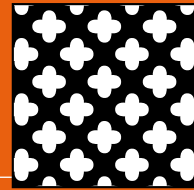

REF. 516

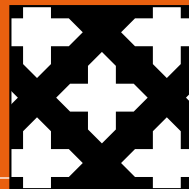

REF. 504

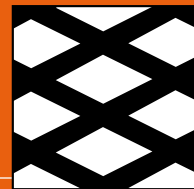

REF. 519

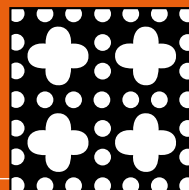

REF. 505

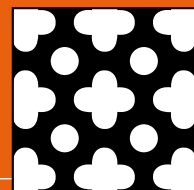

REF. 561

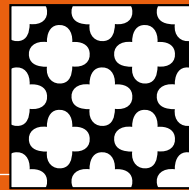

REF. 509

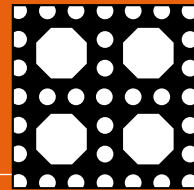

chapas repujadas

CHAPAS REPUJADAS - 2.000x1.000						
MODELO	1,5 FE	2,0 FE	3,0 FE	1,5 GALV.	2,0 GALV.	3,0 GALV.
CACAHUETE 10x26	76,58 €	90,71 €	149,75 €	84,43 €	97,13 €	162,32 €
LAGRIMADA 39x19	76,58 €	90,71 €	149,75 €	84,43 €	97,13 €	162,32 €
P. DIAM. 14x14 ALT.	76,58 €	90,71 €	149,75 €	84,43 €	97,13 €	162,32 €

CHAPAS REPUJADAS - 3.000x1.500						
MODELO	1,5 FE	2,0 FE	3,0 FE	1,5 GALV.	2,0 GALV.	3,0 GALV.
CACAHUETE 10x26	----	220,90 €	315,56 €	----	234,92 €	343,61 €
P. DIAM. 14x14 ALT.	----	220,90 €	315,56 €	----	234,92 €	343,61 €

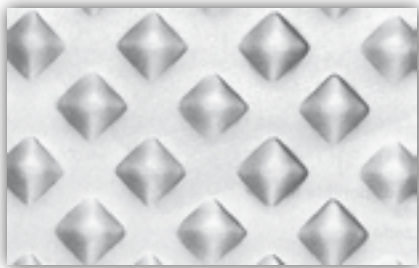

PUNTA DIAMANTE 14x14 ALTERNO

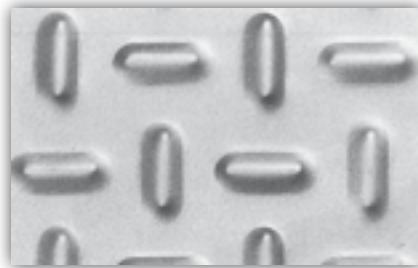

CACAHUETE 10x26



LAGRIMADA 39x19

stepbloc



STEPBLOC - STANDAR 3.000 mm										
ANCHO mm	ALTO mm	CARGA	LUZ EN mm						PRECIO	
			500	750	1000	1250	1500	1750	HIERRO	GALV.
240	50	CC	462	289	205	161	131	111	145,53 €	210,98 €
		CR	6186	2742	1 540	987	683	500	145,53 €	210,98 €
360	50	CC	462	289	205	161	131	111	184,80 €	249,48 €
		CR	4171	1848	1038	665	456	339	184,80 €	249,48 €
480	50	CC	462	289	205	161	131	111	235,62 €	315,70 €
		CR	3126	1385	778	499	342	254	235,62 €	315,70 €

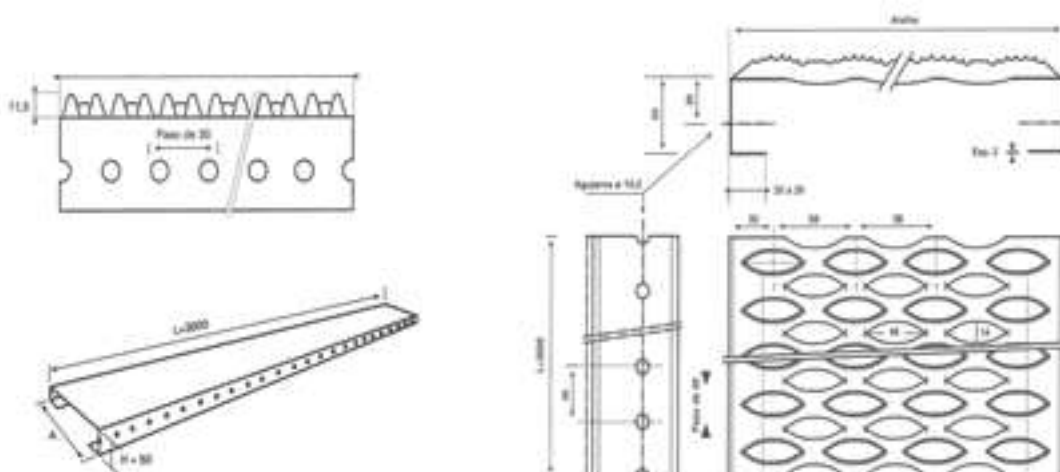

▲ Actualmente disponemos de mallas romboidales y hexagonales de metal deployé, las cuales pueden ser laminadas o no.

▲ Para definir la malla deployé, debemos identificar los 4 parámetros que forman la nomenclatura de la malla.

- Diagonal Corta (DC): Distancia entre centros de dos rombos verticales.
- Diagonal Larga (DL): Distancia entre los centros de dos rombos horizontales.
- Hilo (H): Distancia entre un rombo y el siguiente rombo.
- Espesor de chapa (E): Grueso de la chapa.

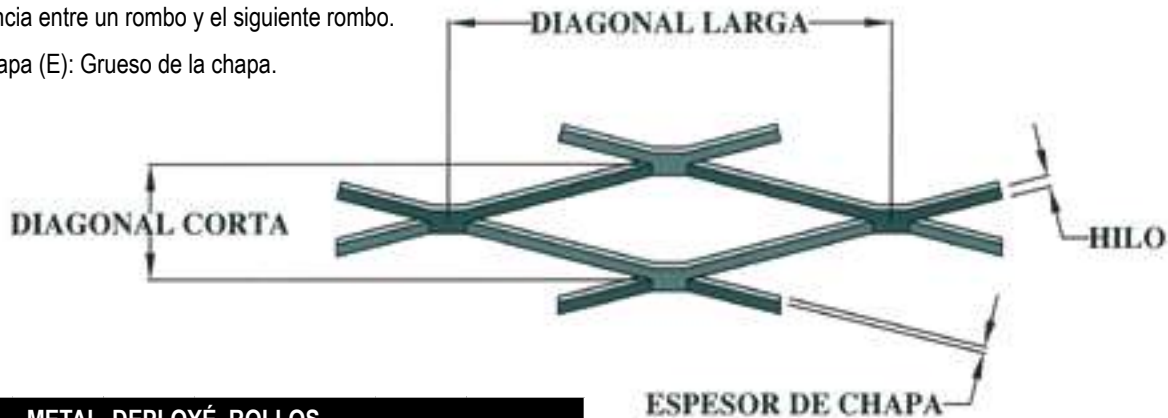

METAL DEPLOYÉ ROLLOS

CÓDIGO	MALLA	ANCHO HILO	ESP. CHAPA	DIMENSIONES		PESO kg/m ²	PRECIO ROLLO
	DC-DL	H	E	Larg. aprox.	Ancho		
5-10-1-1	5-10	1	1	5000	1000	3,2	148,72 €
8-16-1,2-1	8-16	1,2	1	6600	1000	2,4	143,00 €
10-20-1,5-1,5	10-20	1,5	1,5	6600	1000	3,6	162,80 €
13-30-2-1,5	13-30	2	1,5	6500	1000	3,69	154,00 €
13-30-2-1,5	13-30	2	1,5	8200	1250	3,69	242,88 €
13-30-2-1,5	13-30	2	1,5	10000	1500	3,69	355,30 €
25-60-2,5-1,5	25-60	2,5	1,5	10000	1000	3,84	144,32 €
25-60-2,5-1,5	25-60	2,5	1,5	12500	1250	3,84	225,18 €
10-20-1,5-1,5	25-60	3	2	8300	1000	4,20	169,40 €
25-60-3-2	25-60	3	2	10400	1250	4,20	265,32 €
25-60-3-2	25-60	3	2	12500	1500	4,20	382,70 €

METAL 2.000x1.000 y 3.000x1.500

CÓDIGO	MALLA	ANCHO HILO	ESP. CHAPA	DIMENSIONES		PESO kg/m ²	PRECIO POR PLANCHA
	DC-DL	H	E	Larg. aprox.	Ancho		
5-10-1-1	5-10	1	1	2000	1000	3,20	67,54 €/ud
10-20-2-1,5	10-20	2	1,5	2000	1000	4,50	53,90 €/ud
13-30-2-1,5	13-30	2	1,5	2000	1000	3,69	47,38 €/ud
13-30-2-1,5	13-30	2	1,5	3000	1500	3,69	106,70 €/ud
26-60-3-2	25-60	3	2	2000	1000	4,20	41,80 €/ud
26-60-3-2	25-60	3	2	3000	1500	4,20	101,20 €/ud

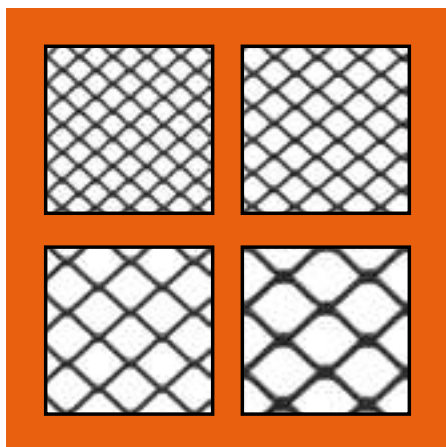

También se fabrican chapas a medida. Consultar.

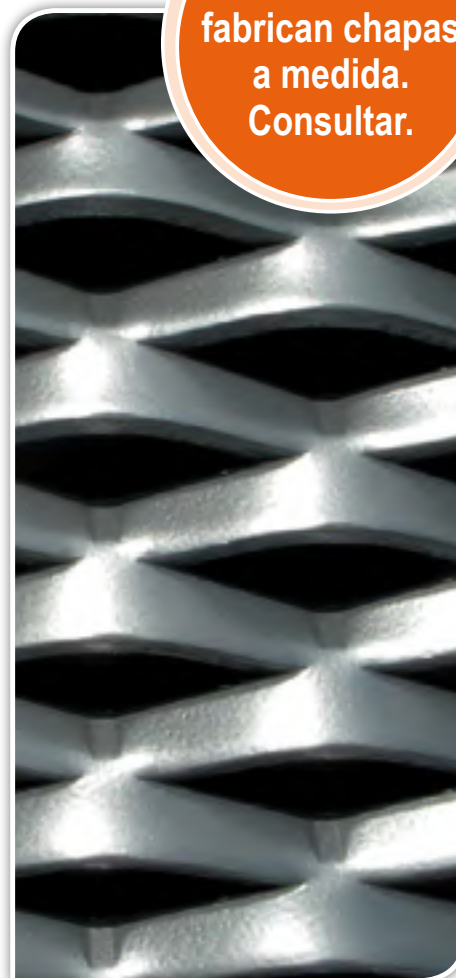



METAL DEPLOYÉ ARQUITECTURA							
CÓDIGO	MALLA	ANCHO HILO	ESP. CHAPA	DIMENSIONES		PESO kg/m ²	PRECIO PLANCHA
	DC-DL	H	E	Larg. aprox.	Ancho		
46-75-20-1,5	46-75	20	1,5	2000	1000	9,60	88,00 €/ud
46-75-20-1,5	46-75	20	1,5	1000	2000	9,60	93,00 €/ud
46-75-20-1,5 GALVANIZADA	46-75	20	1,5	2000	1000	11,60	101,00 €/ud
46-75-24-1,5 GALVANIZADA	46-75	24	1,5	2000	1000	11,60	101,00 €/ud
46-75-20-1,5 GALVANIZADA	46-75	20	1,5	3000	1500	9,60	220,00 €/ud
46-75-24-1,5	46-75	24	1,5	2000	1000	11,60	94,00 €/ud
50-114-20-1,5	50-114	20	1,5	2000	1000	9,30	86,00 €/ud
50-114-24-1,5	50-114	24	1,5	2000	1000	11,50	92,00 €/ud
50-114-24-1,5	50-114	24	1,5	1000	2000	11,50	93,00 €/ud
50-114-24-1,5	50-114	24	1,5	1500	2000	11,50	156,00 €/ud



entramado metálico (tramex)

ENTRAMADO METÁLICO

MEDIDAS	PLETINA 30/2	PLETINA 30/3
200x1.000	22,00 €	31,00 €
250x1.000	26,00 €	39,00 €
300x1.000	29,00 €	44,00 €
400x1.000	35,00 €	0,00 €
500x1.000	41,00 €	60,00 €
600x1.000	48,00 €	0,00 €
700x1.000	55,00 €	0,00 €
800x1.000	62,00 €	0,00 €
900x1.000	70,00 €	0,00 €
1.000x1.000	72,00 €	106,00 €
1.200x1.000	88,00 €	127,00 €
1.500x1.000	108,00 €	157,00 €
2.000x1.000	135,00 €	206,00 €
3.000x1.000	214,00 €	310,00 €

COMPLEMENTOS

FRONTAL - 2.000	42,00 €
GRAPA SUJECIÓN COMPLETA	2,60 €
GRAPA SUJECIÓN PARTE ARRIBA	1,40 €
GRAPA UNIÓN	5,30 €

REJILLA CON MALLA SEG 8x8

MEDIDAS	PLETINA 30/2	PLETINA 30/3
1.000x1.000	143,00 €	173,00 €
2.000x1.000	276,00 €	334,00 €



REJILLAS POLIESTER

MEDIDAS	PLETINAS 30/7	VERDE / GRIS
2.000x1.000		250,00 €

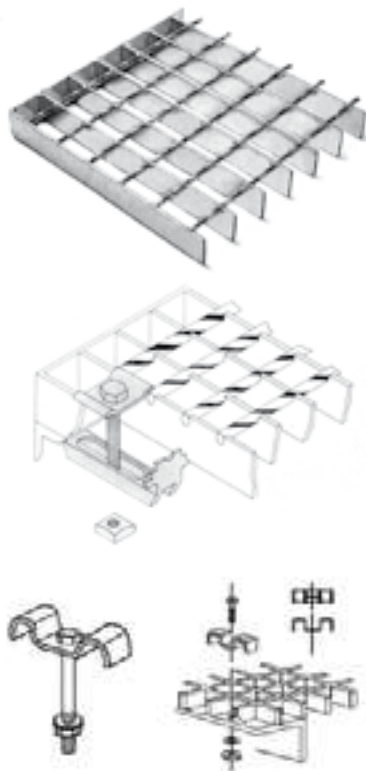

ENTRAMADO METÁLICO ESPECIAL

MALLA	PLET PORTANTE	SEPARADOR	PRECIO €/m²
30x30	20x2	RED 5 mm	102,02 €
30x30	25x2	RED 5 mm	114,78 €
30x30	30x2	RED 5 mm	116,19 €
30x30	30x2	DENT	RED 5 mm 160,12 €
30x30	25x3	RED 5 mm	147,37 €
30x30	30x3	RED 5 mm	155,87 €
30x30	35x3	RED 5 mm	189,88 €
30x30	40x3	RED 5 mm	206,88 €
30x30	30x3	DENT	RED 5 mm 194,13 €
30x30	30x2	8x8	RED 5 mm 172,87 €
30x30	30x3	8x8	RED 5 mm 209,72 €
30x30	40x2	8x8	RED 5 mm 208,30 €
30x30	30x2	DENT 8x8	RED 5 mm 185,63 €
30x30	40x4	RED 5 mm	320,24 €
30x30	50x4	RED 5 mm	368,42 €
30x30	30x5	RED 5 mm	331,58 €
30x30	40x5	RED 5 mm	396,76 €
30x30	60x5	RED 5 mm	548,38 €
30x60	30x3	RED 5 mm	165,79 €
30x19	30x3	RED 5 mm	178,54 €
20x20	30x2	10x2	212,55 €
20x20	30x2	30x2	297,57 €
30x30	30x2	10x2	130,36 €
30x30	30x2	30x2	184,21 €
30x30	30x3	10x3	184,21 €
30x30	30x3	30x3	262,15 €
60x60	30x2	30x2	124,70 €
100x100	30x2	30x2	79,35 €

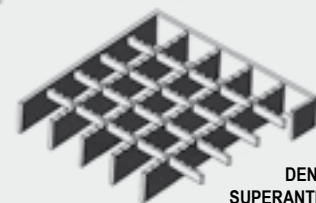
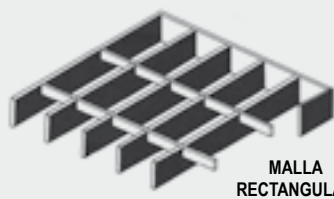

PELDAÑOS

MEDIDAS	PLETINA 30/2	PLETINA 30/3
500x200	24,00 €	
600x240	29,00 €	
700x240	31,00 €	
700x270	33,00 €	
800x240	34,00 €	
800x270	35,00 €	
900x270		49,50 €
1.000x270		53,00 €
1.000x300		56,25 €



TABLA DE CARGAS DE REJILLAS ELECTROFUNDIDO

PORTANTE		500	600	700	800	900	1.000	1.100	1.200	1.300	1.400	1.500	1.600	1.700	1.800	1.900	2.000	2.100	2.200	2.300	2.400	
20x2	U	1.900	1.320	970	742																	
	fu	1,56	2,25	3,06	4,00																	
	C	155	125	104	89																	
	fc	1,5	2,16	2,86	3,66																	
20x3	U	2.851	1.980	1.454	1.113	880	712															
	fu	1,56	2,25	4,00	5,06	6,25	7,5															
	C	234	186	155	133	117	104															
	fc	1,56	2,16	2,86	3,66	4,56	5,56															
25x2	U	2.970	2.062	1.514	1.160	916	742	613														
	fu	1,25	1,80	2,45	3,2	4,05	5,0	6,05														
	C	243	194	162	138	121	107	97														
	fc	1,25	1,73	2,29	2,93	3,64	4,44	5,32														
25x3	U	4.454	3.093	2.272	1.740	1.374	1.113	920	773	658	568											
	fu	1,25	1,80	2,45	3,20	4,06	5,00	6,05	7,20	8,45	9,80											
	C	365	292	243	208	182	162	146	132	121	112											
	fc	1,25	1,73	2,29	2,93	3,64	4,44	5,32	6,28	7,32	8,44											
30x2	U	4.275	2.969	2.181	1.670	1.320	1.069	883	742	632	545											
	fu	1,04	1,5	2,04	2,67	3,38	4,17	5,04	6,00	7,04	8,17											
	C	350	280	234	200	175	155	140	127	117	107											
	fc	1,04	1,44	1,91	2,44	3,04	3,70	4,44	5,24	6,10	7,04											
30x3	U	6.414	4.454	3.272	2.505	1.980	1.603	1.324	1.113	948	817	712	626	554								
	fu	1,04	1,50	2,04	2,67	3,38	4,17	5,04	6,00	7,04	8,17	9,38	10,67	12,04								
	C	526	421	350	300	236	234	209	191	175	162	150	140	131								
	fc	1,04	1,44	1,91	2,44	3,04	3,70	4,44	5,24	6,10	7,04	8,04	9,10	10,24								
30x5	U	11.520	8.000	5.878	4.500	3.556	2.880	2.380	2.000	1.704	1.469	1.280	1.125	997	889	798						
	fu	1,3	1,9	2,6	3,4	4,3	5,3	6,4	7,6	8,9	10,4	11,9	13,5	15,3	17,1	19,1						
	C	956	764	636	545	478	425	382	348	319	294	273	255	239	225	213						
	fc	1,3	1,8	2,4	3,1	3,9	4,7	5,6	6,6	7,7	8,9	10,2	11,6	13,0	14,5	16,1						
40x2	U	7.602	5.274	3.879	2.969	2.345	1.900	1.570	1.320	1.124	969	844	742	657q	586							
	fu	0,78	1,12	1,53	2,00	2,53	3,13	3,78	4,50	5,28	6,13	7,03	8,00	9,03	10,12							
	C	624	493	415	356	312	277	248	226	207	191	178	165	155	146							
	fc	0,78	1,08	1,43	1,83	2,28	2,78	3,33	3,93	4,58	5,28	6,03	7,68q	8,58	9,43							
40x3	U	11.402	7.919	5.818	4.454	3.519	2.851	2.355	1.980	1.686	1.454	1.266	1.113	986	880	789	712	646				
	fu	0,78	1,13	1,53	2,00	2,53	3,13	3,78	4,50	5,23	6,13	7,03	8,00	9,03	10,13	11,28	12,50	13,78				
	C	934	748	624	534	467	415	374	339	312	287	266	249	234	220	207	197	186				
	fc	0,78	1,08	1,43	1,83	2,28	2,78	3,33	3,93	4,58	5,28	6,034	6,83	7,68	8,58	9,53	10,53	11,58				
40x4	U	15.204	10.558	7.756	5.939	4.692	3.801	3.142	2.640	2.249	1.939	1.688	1.484	1.314	1.172	1.053	950	861	785			
	fu	0,78	1,13	1,53	2,00	2,53	3,13	3,78	4,50	5,28	6,13	7,03	8,00	9,03	10,13	11,28	12,50	13,78	15,13			
	C	1.247	997	831	712	624	554	498	453	415	383	356	332	312	293	277	262	248	237			
	fc	0,78	1,08	1,43	1,83	2,28	2,78	3,33	3,93	4,58	5,28	6,034	6,83	7,68	8,58	9,53	10,53	11,58	12,68			
40x5	U	20.475	14.219	10.446	7.998	6.319	5.119	4.230	3.555	3.029	2.612	2.275	2.000	1.771	1.580	1.418	1.280	1.161	1.058	968	889	
	fu	1,00	1,4	1,9	2,5	3,2	4,0	4,8	5,7	6,7	7,8	8,9	10,2	11,5	12,9	14,3	15,9	17,5	19,2	21,0	22,9	
	C	1.670	1.336	1.113	954	835	742	682	607	557	514	477	445	418	393	371	351	334	318	303	291	
	fc	1,00	1,4	1,8	2,3	2,9	3,5	4,2	5,0	5,8	6,7	7,7	8,7	9,7	10,9	12,1	13,4	14,7	16,1	17,6	19,1	
50x4	U	25.590	17.771	13.056	9.996	7.898	6.397	5.287	4.443	3.785	3.264	2.843	2.499	2.214	1.975	1.772	1.599	1.451	1.322	1.209	1.111	
	fu	0,8	1,1	1,6	2,0	2,6	3,2	3,8	4,6	5,4	6,2	7,1	8,1	9,2	10,3	11,5	12,7	14,0	15,4	16,8	18,3	
	C	2.055	1.644	1.370	1.174	1.027	914	840	745	685	632	587	548	514	483	457	433	411	391	374	357	
	fc	0,8	1,1	1,5	1,9	2,3	2,8	3,4	4,0	4,6	5,4	6,1	6,9	7,8	8,7	9,7	10,7	11,8	12,9	14,0	15,3	
60x5	U		32.000	23.510	18.000	14.222	11.520	9.521	8.000	6.817	5.878	5.120	4.500	3.986	3.558	3.191	2.880	2.612	2.380	2.178	2.000	
	fu		1,0	1,3	1,7	2,1	2,6	3,2	3,8	4,5	5,2	6,0	6,8	7,6	8,6	9,6	10,6	11,7	12,8	14,0	15,2	
	C		2.911	2.426	2.079	1.819	1.617	1.488	1.323	1.212	1.120	1.039	970	910	856	809	766	728	694	661	633	
	fc		0,9	1,2	1,5	1,9	2,4	2,8	3,3	3,9	4,5	5,1	5,8	6,5	7,3	8,1	8,9	9,8	10,7	11,7	12,7	

» U: Carga uniformemente repartida. » fu: flecha U en mm. » C: Carga concentrada sobre una superficie de 200x200. » fc: flecha C en mm.

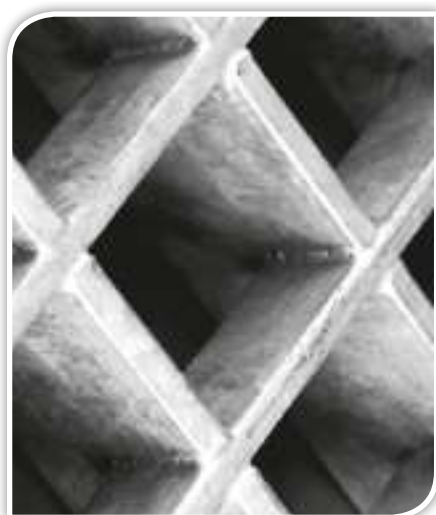

DETALLE CARGAS PESADAS PARA TODAS LAS MALLAS 34,3 DE PLETINA PORTANTE

LONGITUD MÁX. ENTRE APOYOS (mm)	CARGAS PESADAS								
	CARGA RUEDA kg	450	1.000	2.000	3.500	5.000	1.000	2.000	3.500
	HUELLA mm	160x160	200x200	200x200	250x250	250x250	140x140	160x160	200x200
25x3		325	250	175	175	150	175	125	125
30x2		325	225	175	175	150	175	125	125
30x3		450	300	200	200	175	200	150	150
30x5		700	425	250	250	200	300	200	200
35x3		575	375	225	225	175	275	175	175
40x2		500	325	200	200	175	225	175	150
40x3		750	450	275	250	200	325	225	200
40x4		950	575	350	300	225	400	275	225
40x5		1.175	700	400	325	275	500	325	250
45x5		1.450	850	475	375	300	625	400	300
50x4		1.450	850	475	375	300	625	400	300
60x5		1.900	1.425	775	575	450	1.100	625	475

MODELO	LARGO	ANCHO	ACABADO	PRECIO FINAL
VENTANA 11 LAMAS	4000	645	HIERRO	134,00 €
VENTANA 11 LAMAS	4000	645	GALVA	146,00 €
VENTANA 05 LAMAS	4000	295	HIERRO	68,00 €
VENTANA 05 LAMAS	4000	295	GALVA	73,00 €

11 LAMAS



5 LAMAS

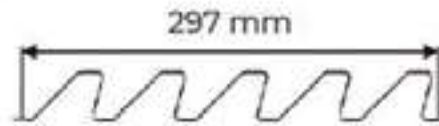

Ventanas

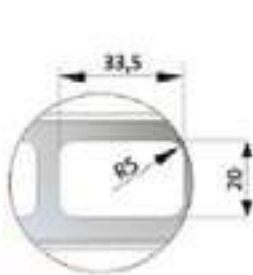

Microperforado

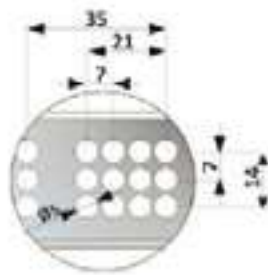

Multiperforado

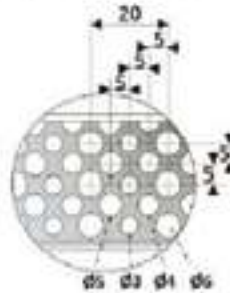

Ciego

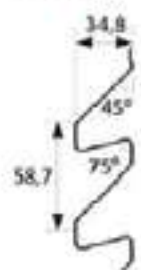

PELDAÑO CHAPA REPUJADA	
MEDIDA	PRECIO
600x290	31,15 €
700x290	36,40 €
800x290	41,44 €
900x290	46,62 €
1.000x290	51,80 €

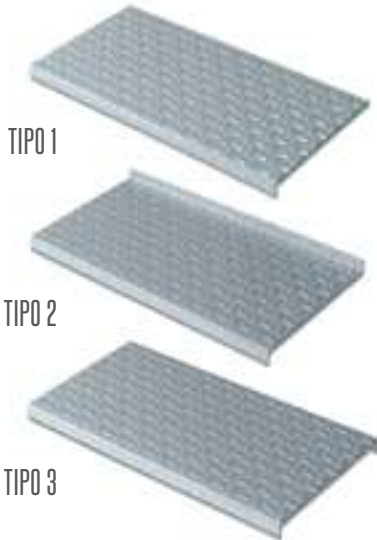

PELDAÑO REPUJ. 14x14		
MEDIDA	NEGRO	GALV.
600x250	19,60 €	22,40 €
700x250	21,00 €	23,80 €
800x250	23,80 €	26,60 €
900x250	26,60 €	30,10 €
1.000x250	29,40 €	33,60 €
2.000x250	47,60 €	54,60 €



PELDAÑO INT. GOMA.		
MEDIDA	TIPO A	TIPO B
600x250	36,00 €	43,25 €
700x250	42,00 €	49,10 €
800x250	49,50 €	57,00 €



PELDAÑO ABOC. 7x20			
MEDIDA	TIPO A		TIPO B
	NEGRO	GALV.	NEGRO
600x250	20,79 €	25,41 €	35,00 €
700x250	26,18 €	29,64 €	36,40 €
800x250	29,26 €	33,88 €	37,80 €
900x250	35,42 €	42,56 €	
1.000x250	40,04 €	48,16 €	



PELDAÑO RECANORM.		
MEDIDA	NEGRO	GALV.
600x250	22,20 €	25,49 €
700x250	25,89 €	29,75 €
800x250	29,53 €	33,99 €
1.000x250	36,93 €	42,69 €
2.000x250	69,66 €	80,23 €



PELDAÑOS CARACOL EXTERIOR

MEDIDAS	CON ESCOTE	CON TUBO
600x340	50,40 €	77,70 €
700x360	57,75 €	85,40 €
800x380	65,80 €	92,75 €



PELDAÑOS CARACOL INTERIOR

MEDIDAS	CON ESCOTE	CON TUBO
600x340	64,75 €	91,70 €
700x360	77,35 €	104,23 €
800x380	90,09 €	116,76 €



PELDAÑOS SOPORTE MADERA

MEDIDAS	CON ESCOTE	CON TUBO
600 mm	42,00 €	78,40 €
700 mm	46,20 €	82,60 €
800 mm	51,80 €	88,20 €



COMPLEMENTOS PELDAÑOS METÁLICOS

TIPO	BARANDAS	PASAMANOS
Nº 1	54,60 €	
Nº 2	60,55 €	
Nº 101	59,71 €	47,60 €
Nº 102	65,80 €	56,49 €

COMPLEMENTOS PELDAÑOS MADERA

TIPO	BARANDAS	PASAMANOS
Nº 3	106,40 €	
Nº 103	115,50 €	

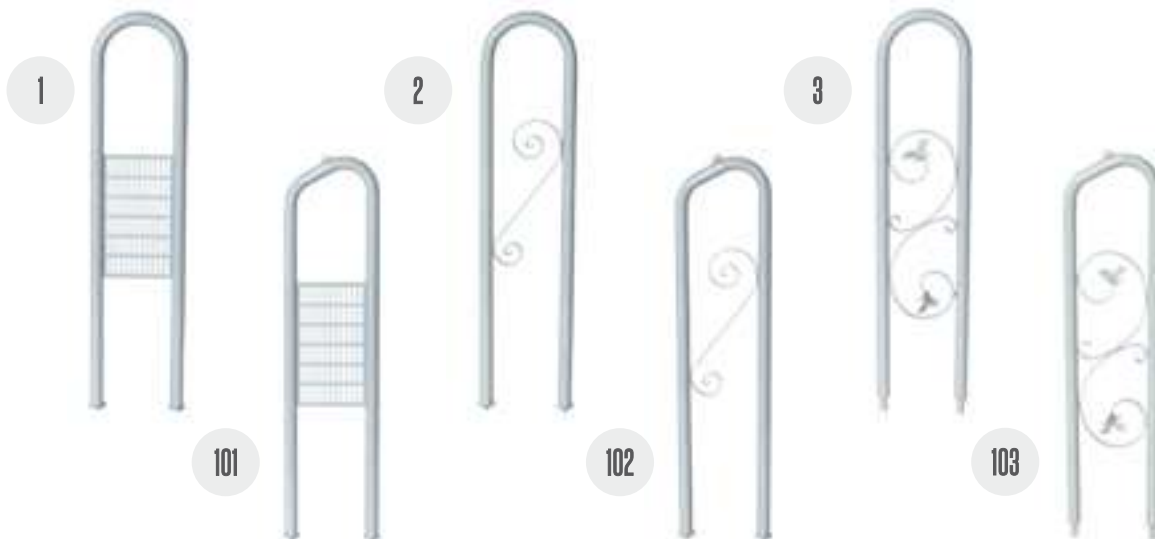

REMATE 1



REMATE 2

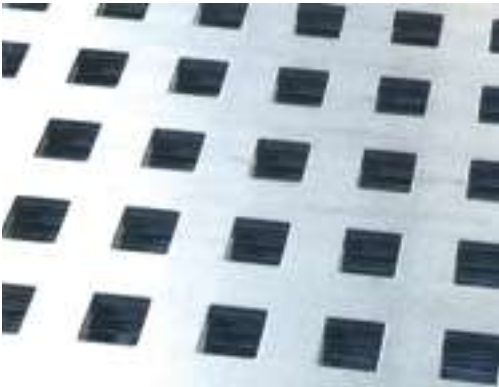
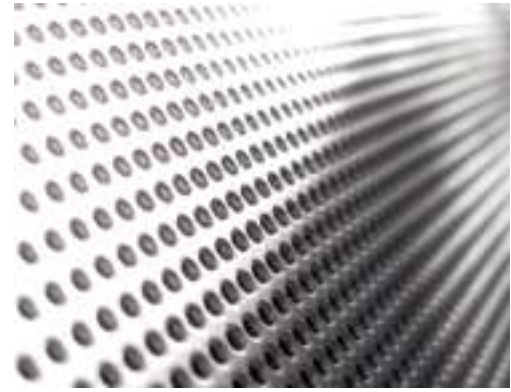

Siempre a tu Servicio



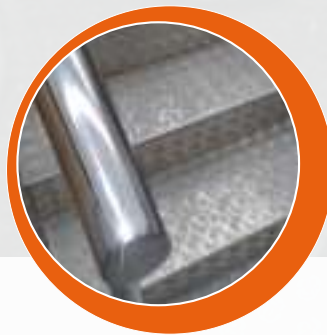
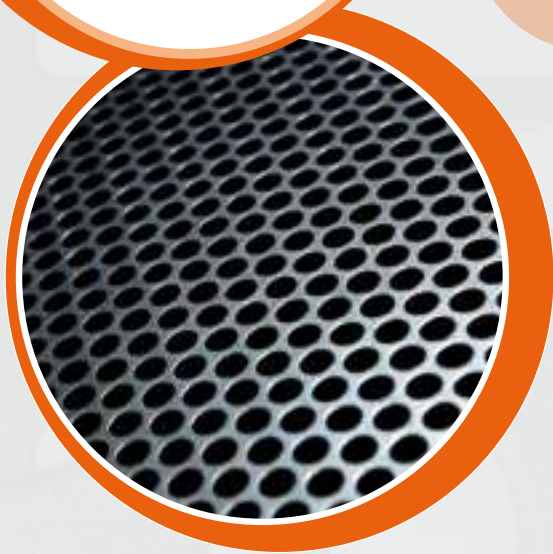

SUMINISTROS MALPICA, S.L.

Polígono Valdeconsejo ♦ C/ Sierra Guara - Pc. 11 - Nv. 1-2 ♦ 50410 Cuarte de Huerva (Zaragoza)

Tel. Oficina_ 976 577 100 ♦ Tel. Almacén_ 976 577 285 ♦ Fax_ 976 577 302

ventas@suministrosmalpica.es ♦ www.suministrosmalpica.es